

LiFePO₄

HIGH VOLTAGE CABINET MANUAL

Operation and Maintenance



SUPPORT

If you are experiencing technical problems and cannot find a solution in this manual, please contact us for further assistance.



Description

This manual describes in detail the requirements and procedures for safe installation and operation of lithium battery pack. Please read this manual carefully. Only qualified persons are allowed to install, operate and maintain the system, otherwise it may cause product damage or personal safety risks.

Any actions against safety operation, or do not follow rules of this manual and limited warranty letter, will void warranty and qualification of this product. Meanwhile, the manufacturer will be not responsible for the product damage, property damage, personal injury or even death.

The information contained in this manual is accurate when it's issued. Reserves right to change specification (such as optimization, upgrade or other operations) without prior notice, and please always view the latest document via QR code on the label.

In addition, please noted that the diagrams/schematics in this document are used to help understand system configuration and installation instructions, which may be different from the actual items in the installation.

Contents

I. Information	1
1.1 Validity	1
1.2 Target Group	1
1.3 Levels of Warning Messages	1
1.4 Symbol Description	2
1.5 Abbreviation Description	3
II. Safety	4
2.1 Safety Precautions	4
2.2 Safety Instructions	4
2.2.1 Safety gear	5
2.2.2 Emergency safety measures	5
2.2.3 Other Tips	6
III. Product Overview	6
3.1 Introduction	6
3.2 Features	7
3.3 Specification	8
3.4 High Voltage Cabinet Parameters	10
3.5 Key Device Parameter Table	11
3.6 Panel function requirements	14
3.7 Description of shape and installation size	16
IV. Lithium Battery IoT Cloud	17
4.1 App Download	17
4.2. Log in and register	17
4.3. Equipment distribution network	20
4.4. APP page	23
4.5. Mine	26
4.6. Message	31
4.7. App settings	32

V. Installation	34
5.1 Preparation	34
5.1.1 Safety Compliance	34
5.1.2 Environment	34
5.1.3 Tools	34
5.2 Inspection	35
5.2.1 Unpack precautions	35
5.2.2 Scope of delivery	35
5.3 Start Installation	37
5.3.1 Reminder	37
5.3.2 Procedures	37
VI. Cable Connection and Commissioning	39
6.1 Get Battery Ready	39
6.2 Communication Cable Connection	39
6.3 DC Power Cable Connection	40
6.4 Connecting with Inverter	40
6.5 Commissioning	41
6.6 Switch off Battery	41
VII. Troubleshooting	43
VIII. Transport and Storage	44
IX. Disposal of Battery	44

I. Information

1.1 Validity

This document is valid for: **LB20000S**

1.2 Target Group

This document is intended for qualified persons and operators. Only qualified persons are allowed to perform activities marked with a warning symbol and the caption "Qualified person" in this document. Qualified persons must have the following skills:

- * Knowledge of how lithium iron phosphate batteries work and are operated.
- * Knowledge of how an energy storage system (including PV/battery/hybrid inverter, MPPT, Meter, Distribution box etc.) works and is operated.
- * Knowledge of local applicable connection requirements, standards, and directives.
- * Training in the installation and commissioning of electrical devices, batteries.
- * Training in how to deal with the dangers and risks associated with installing, repairing and using electrical devices and batteries.

1.3 Levels of Warning Messages

The following levels of warning messages may occur when handling the product.



DANGER

Indicates a hazardous situation which, if not avoided, will result in death or serious injury.



WARNING

Indicates a hazardous situation which, if not avoided, could result in death or serious injury.



CAUTION

Indicates a hazardous situation which, if not avoided, could result in minor or moderate injury or product permanent damage.













NOTICE



Indicates a situation which, if not avoided, can result in property damage or product not work or accelerated product damage.

1.4 Symbol Description

1.4.1 Symbols on products label

Symbols	Definition
	Indicates the danger of electric shock. If not avoided, it would cause casualties.
	Indicates a potentially dangerous condition which could result in injury or death.
	Indicates important information or warnings related to concepts talked about in the text.
	Indicates more information is available in other documents relating to the subject and reader.
	Indicates important steps or tips for optimal performance.
	Do not place the battery within children/pets' touchable area
	Do not place the battery near heat source and flammable material.
	Do not expose the battery to direct sunlight, rain and snow.
	Do not short circuit the battery.
	Recycle label
	WEEE designation

1.4.2 Other symbols

Label	Definition
 Qualified person	Indicates activities that can only be performed by qualified persons
	Grounding point

1.5 Abbreviation Description

Abbreviation	Definition
Battery/battery pack/battery module	Single LB20000S rechargeable lithium rechargeable lithium iron phosphate battery pack including cells, BMS and enclosure etc.
Battery system/ cluster	Multiple LB20000S battery pack connected in series with power, communication and grounding cables and installation auxiliaries.
BMS	Battery management system Electronical Unit to ensure lithium cells' safety and display information or control the battery work mode.
SOC	State of charge The battery state of charge refers to the percentage of the remaining capacity and rated capacity of the battery.
SOH	State of health The battery health status refers to the percentage between the full charged capacity and the rated capacity of the battery.
DIP switch	Dual in-line package switch

II. Safety

2.1 Safety Precautions



DANGER

- Do not impact the battery with heavy objects.
- Do not squeeze or pierce the battery pack.
- Do not throw the battery pack into the fire.



WARNING

Fire risk

- Do not expose the battery pack to the condition over 80°C.
- Do not put the battery near a heat source, such as a fireplace.
- Do not expose the battery pack to direct sunlight or raining.



WARNING

Electric shock risk

- Do not allow non-qualified person to disassemble the battery pack.
- Do not touch the battery pack with wet hands.
- Do not expose the battery pack to moisture or liquid environment.



NOTICE

Damage risk

- Do not short-circuit or reverse connect the battery.
- Do not use chargers or charging devices unapproved by the manufacturer to charge the battery.
- Do not mix batteries from different manufacturers or different kinds, types or brands.

2.2 Safety Instructions

The battery has been designed and tested in accordance with international (such as UL, IEC, UN38.3 etc.) safety requirements. However, Due to various factors during the whole lifetime process, we cannot guarantee absolute safety, in order to prevent personal injury and property damage and ensure long-term operation of the battery, please do read and following the below section carefully to operate the battery and handle emergency situations.

2.2.1 Safety gear

It is required to wear the following safety gear when Insulated Gloves, Safety Glasses, Safety Shoes.



2.2.2 Emergency safety measures

* Water invasion

Please cut off the AC power supply of the system first and then disconnect all switches under the premise of ensuring safety.

* Electrolyte or gas leakage

If the battery pack leaks electrolyte, avoid contact with the leaking liquid or gas. If one is exposed to the leaked substance, immediately perform the actions described below.

·Gas Inhalation: Evacuate the people from the contaminated area and seek medical aid immediately.

·Eye Contact: Flush your eye with clean and flowing water for 15 min, and then seek medical aid immediately.

·Skin Contact: Thoroughly rinse the exposed area with soap and water to be sure no chemical or soap is left on them, and seek medical aid immediately.

·Ingestion: Induce vomiting, and seek medical help immediately.



WARNING

In case of fire situations, please use carbon dioxide fire extinguisher rather than liquid to put out fires.

2.2.3 Other Tips

- All the product are strictly inspected before shipment, Please contact us for replacement if you notice there are any defectives such as swelling etc.
- Do not disassemble batteries and components, otherwise the manufacturer will not be responsible for any damage caused by unauthorized disassembly or repair.
- Enable the battery to be safely grounded before use to make sure the system in safe and normal operation.
- Please ensure that the electric parameters of these devices are compatible mutually before connecting the battery to other devices.
- Please take the environmental factors into careful considerations to ensure that the system can work in a suitable condition as the environment and storage methods have a certain impact on the service life and reliability of this product.

III. Product Overview

3.1 Introduction

The LB20000S battery is designed for residential application and works as a storage unit in the photovoltaic system. It is a high Voltage Li-ion battery storage system, with BMS inside itself. It could be operated in both on-grid, back-up and off-grid modes with compatible inverters. Below is the general schematic of an ac-coupled system.

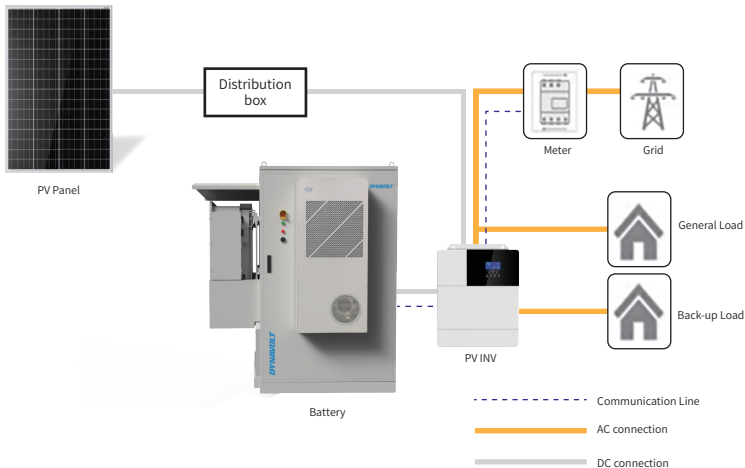

3.2 Features

- Highest safety, battery is made from LiFePO₄ chemistry and comply with the highest international safety and transportation standards
- Build-in pre-charge circuit to avoid rush current when connecting with different inverter/chargers.
- Automatic dynamic addressing function when connected multiple batteries together.
- Rapid shutdown function for North American market.
- Support a maximum of 96% DOD under off-grid and back-up application
- LiFePO₄ as cathode material and automatic balancing function to meet long cycle life
- Compact size and light weight for easy installation and maintenance.

3.3 Specification

3.3.1 Dimension

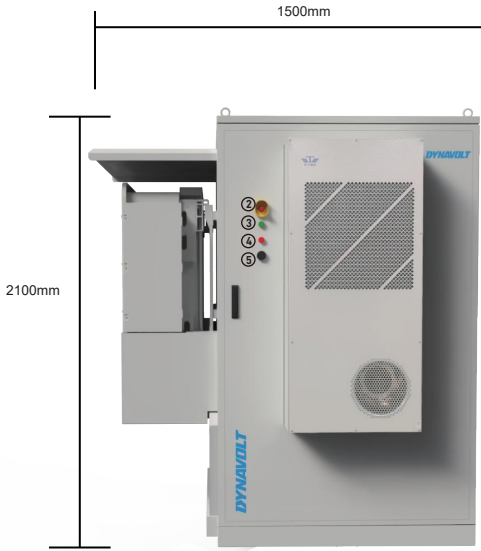

①	125KW Inverter
②	Emergency stop switch
③	RUN
④	ALM
⑤	Signal antenna

3.3.2 Parameters

Items	LB20000S	
Nominal voltage	832V	
Voltage range	702~949V	
Usable energy	261kWh	
Nominal capacity	314Ah	
Dimension	1500W*1450D*2100Hmm	
Weight	2700kg	
Standard charge current	160A	
Max. charge current	320A (Continuous 1 min)	
Standard discharge current	160A	
Max. discharge current	320A (Continuous 1 min)	
Communication	RS485 /CAN/RS232	
Operating temperature	Charge: 0~55°C Discharge:-20~55°C	
Storage temperature	25~40°C	
	Environment at the shipment state	60±25%R.H.



NOTICE

The optimum operating temperature range is from 15°C to 30°C, Frequent exposure to the harsh temperatures may worsen the performance of the battery pack and cycle life.

3.4 High Voltage Cabinet Parameters

3.4.1 Product functions and features

1. The standard working voltage of the product is DC24V, but it can be replaced with battery cluster terminal power supply according to project needs to meet the needs of various energy storage occasions;
2. The product supplies power to the battery management module of the energy storage system and supports DC24V power supply to power the battery module fan to meet the thermal management function requirements of the battery cluster;
3. The product supports CAN communication or daisy chain communication functions with the battery management slave module and master control module of the energy storage system to realize the summary and management of battery cluster information;
4. The product supports 4G or Wi-Fi remote monitoring and management functions, which can realize 7x24h online monitoring of battery clusters;
5. The product supports manual opening and closing and automatic shunt control functions of DC circuit breakers;
6. The product has accurate battery cluster terminal voltage detection, group terminal current detection and battery cluster insulation status detection functions;
7. The product supports temperature detection of copper bars and power connectors in the high-voltage box to ensure the safety of system operation;
8. The product selects high-reliability devices, adopts multiple redundant protection measures, and fully considers the possible harsh electromagnetic environment, high temperature, vibration and other environments in the energy storage system. The product has high reliability, high stability and high anti-interference performance;
9. The system can be applied to various energy storage application scenarios including power station energy storage and cascade utilization energy storage.

10. Basic parameters:

NO.	project	specifications	remarks	
1	rated current	160A		
2	peak point current	320A, 1min		
3	voltage range	300~1000V		
6	work environment	storage humidity	RH ≤95%	no condensation
7		operating ambient temperature	-40~55 °C	
8		Application altitude	≤4000m	
9		IP grade	IP20	
10		cooling-down method	natural cooling	
		corrosion protection	C3	
		grade		
		designed life	10 years	

3.5 Key Device Parameter Table

order number	name	quantity	functional description	specifications	remarks
1	circuit breaker	1	Manual and automatic disconnection of battery cell circuit	BM6TD-320HULZ/2 340/320A/DC24V split voltage/one auxiliary contact set/A-type handle/150mm connecting rod length	North Yuan
2	DC contactor	2	Automatic Split and Join of Battery Cell Cathode Circuit	JEV250A-24S	IXT
3	DC contactor	1	Automatic Split and Join of Battery Cell Negative Circuit	JEV250A-24S	IXT
4	Pre-charged contactor	1	automatic opening and closing of pre-charge circuit	EVHC50-24S (-1 type connector)	IXT
5	Pre-charge resistor	1	Pre-charge and circulating current limiting	RXLG200W100 euros	Ultron
6	Shunt	1	electric current measurement	GFLEV 8436D-500A-35mVC	dicyclo Configurable
7	fuse	1	protecting main circuit current	SEV-43F-400A-1000V	super fusion

8	Switching Mode Power Supply	1	supply electricity LM350-2	LM350-22B24R2	Jinsheng yang ACDC
9	Switching Mode Power Supply	1	supply electricity	PV350-29B24	Jinsheng yang ACDC
10	control unit	1	battery cluster control management unit	P721	Yudan
11	HALL	1	current acquisition	LA56S150S05EY	TAMURA
12	power connector	1	high voltage loop input and output	CN1P300-001 And CN1P300-002	Huangsheng
13	mains switch	1	power supply control	YJ-GQ22AF-20Z/N	Yijia
14	Power outlet	1	AC power input PGSTF	YJ-GQ22AF-20Z/N	Yijia
15	Power outlet	1	AC power input PGSTF	PGSTF-508-03P	stationary Configurable plug
16	Communication socket	3	Communication input/output	PGSTF-508-04P PGSTF-508-05P PGSTF-508-06P	stationary Configurable plug
17	Communication socket	3	Communication input/output	WH63N9080006VF3 G000	Wohu

3.6 Panel functional requirements

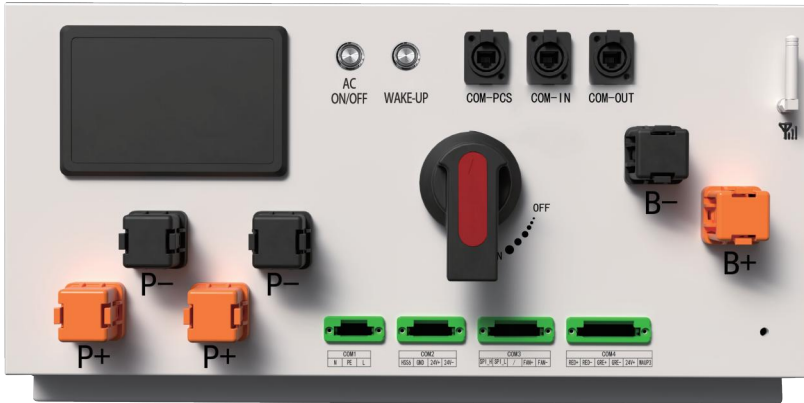

4 High voltage box output interface definition

3.6.1 Definition of high voltage power input/output interface

Interface definition	function declaration	remarks
B+	Cluster input positive terminal	Connect the positive terminal of battery family
B-	Cluster input negative terminal	Connect the negative terminal of the battery cluster
P+	PCS input positive terminal	Connect PCS positive terminal
P-	PCS input negative	Connect PCS negative terminal

3.6.2 Port definition

Serial number	COM port	Definition	Function declaration
1	COM1(3P)	N	
2		PE	
3		L	
1	COM2(4P)	HSS6	
2		GND	
3		24V+	
4		24V-	
1	COM3(5P)	ISOSPI _ H	
2			
3		/	Fan powered output +
4		FAN +	
5		FAN +	Fan power output
1	COM4 (6P)	Red light +	
2		Red light-	
3		Green light +	
4		Green light-	
5		24V +	In the absence of an emergency stop device, a jumper shall be installed across this interface
6		WKUP3	
1	PCS	RS485A	
2		RS485B	
3		CAN1G	
4		CAN1H	
5		CAN1L	
6		RS485G	
7		CAN0H	
8		CAN0L	
1	COM-IN	RS485A	Insert an RJ45 connector into one of the ports to create a loopback
2		RS485B	
3		CAN0G	
4		CAN1H	
5		CAN1L	
6		COM _ DL	
7		CAN0H	
8		CAN0L	
1	COM-OUT	RS485A	
2		RS485B	
3		CAN0G	
4		CAN1H	
5		CAN1L	
6		COM _ DO	
7		CAN0H	
8		CAN0L	

3.7 Description of shape and installation dimensions

3.7.1 External dimensions of high voltage box

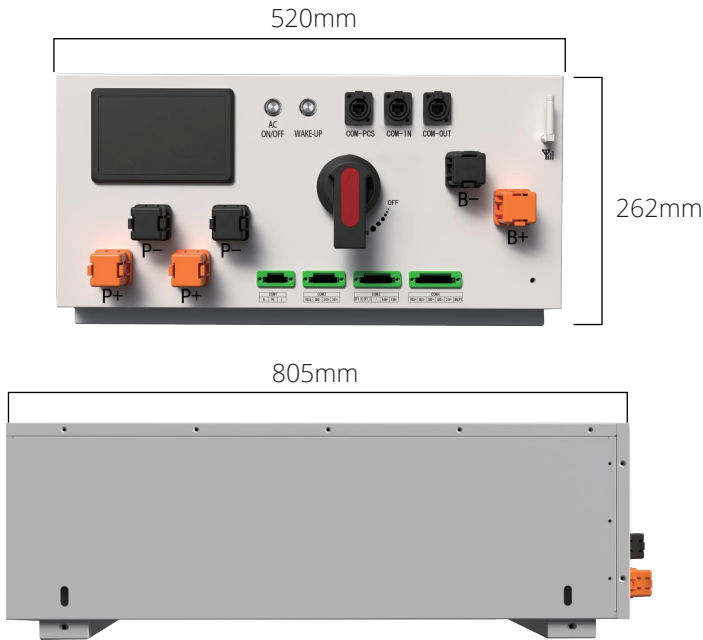

Illustration of the size of the high pressure box

3.7.2 Installation instructions of high voltage box

1. The installation mode of this high-voltage box is ear fixing, which can be disassembled. The default configuration of the box has ears;
2. The size of the ear can be customized according to customer requirements to meet different size requirements;
3. The high voltage box is neutral, no LOGO, and the color can be customized;

3.8 Technical support and service

Our company is equipped with dedicated technical service personnel who provide comprehensive support and services throughout the pre-sales, sales, and after-sales stages. If you have any questions about product information, technology, or usage, feel free to contact us at any time. You can also reach us by visiting our website, sending emails, making faxes, or following our WeChat official account. We will respond to your inquiries as soon as we receive them. All members of Youdan look forward to engaging with you!

For related product use and technical issues, please contact us through our website or email. We will reply to you as soon as we receive the information. We look forward to communicating with you!

IV. Lithium Battery IoT Cloud

4.1. App Download

4.1.1 Android Verison

1. Enter the official website of Youdan Technology <https://www.udantech.com/#/> , click on the "SAAS Application" column in the top navigation bar, pull down to the mobile app application module, and you can see the mobile WeChat Mini Program and App application download



Scan the code to download the App

4.1.2 iOS Verison

Enter the mobile App Store, search for "Xiaodan Energy Storage", and you can download and install it.

4.2. Log in and register

4.2.1 Log in

- After opening the APP, enter the login interface to log in with your account.
- Currently supports logging in through email accounts

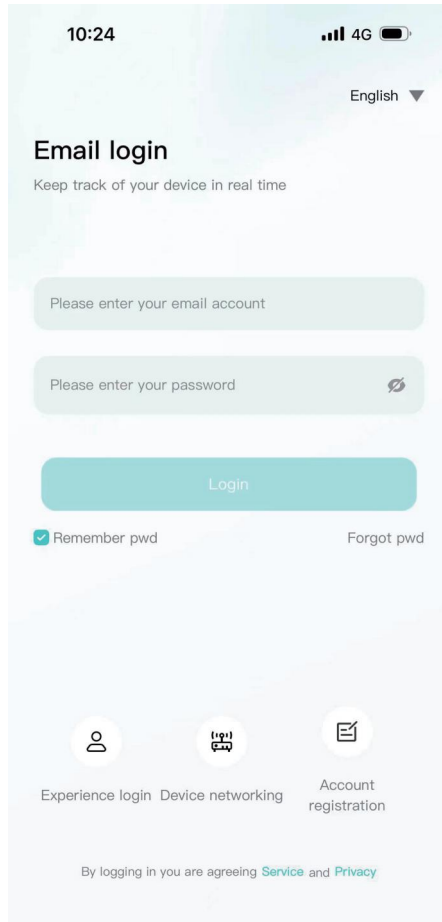

4.2.2 Register

- At the bottom of the login page, click the "Account Registration" button to enter the registration process.
- Currently, you can register with an email account. After registration, you need to go through the device verification process and enter the device SN code or device QR code for identification.

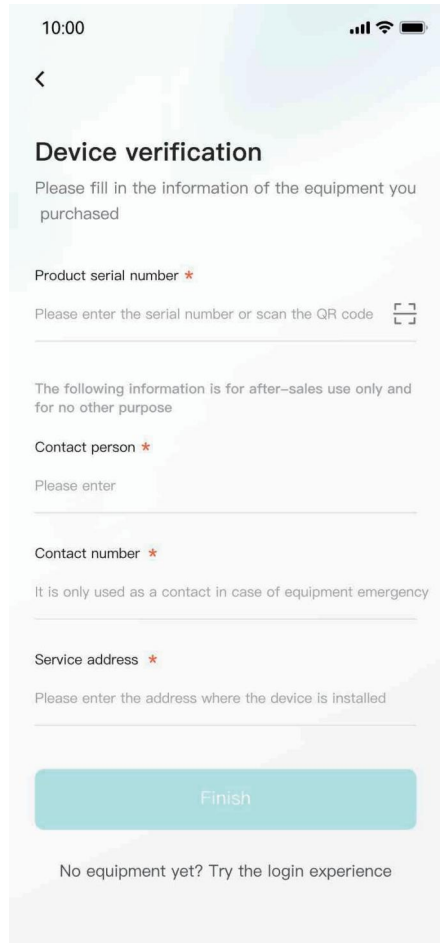
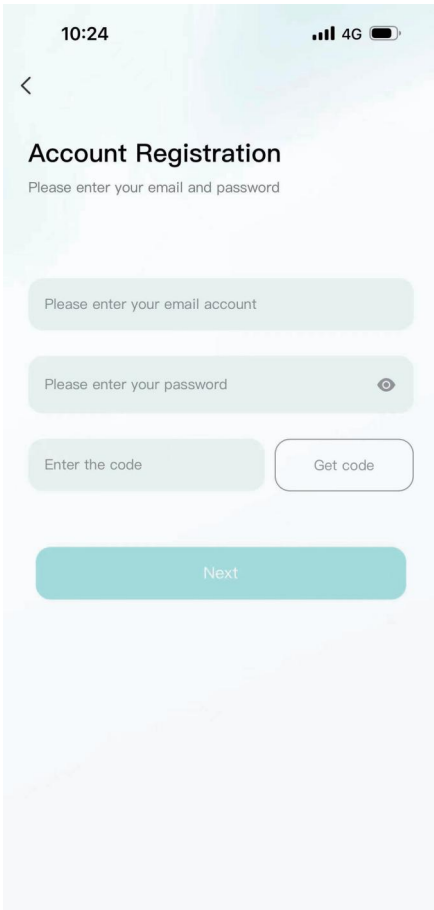

4.2.3 Experience login

- At the bottom of the login page, click the "Experience Login" button to experience the app function without registration as a tourist.

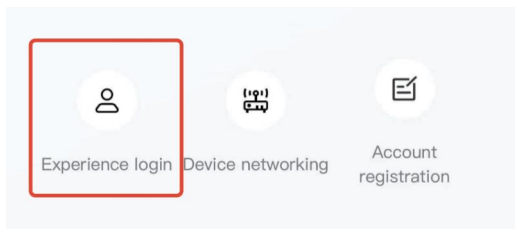

4.3. Equipment distribution network

4.3.1. Overview

Device distribution network refers to connecting devices to the Cloud Computing Platform to help users obtain real-time device data information.

4.3.2. Distribution process

1. Preparation before distribution: Ensure that the **device is on** , turn on the **mobile phone Bluetooth and wireless LAN** functions.

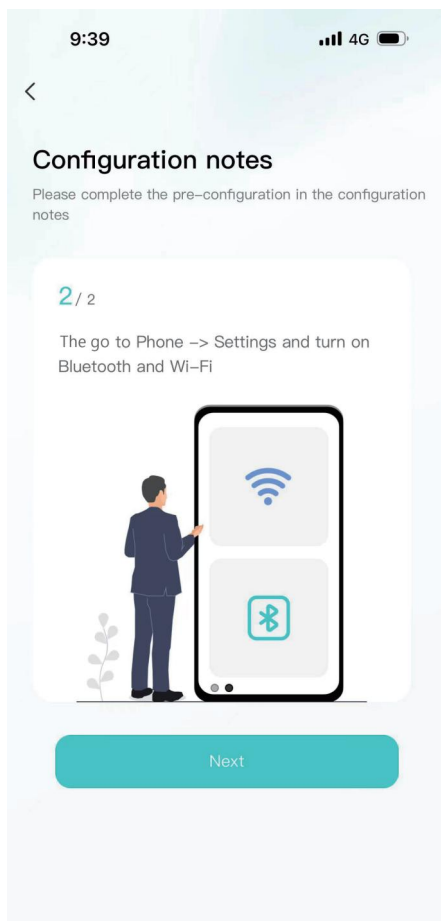
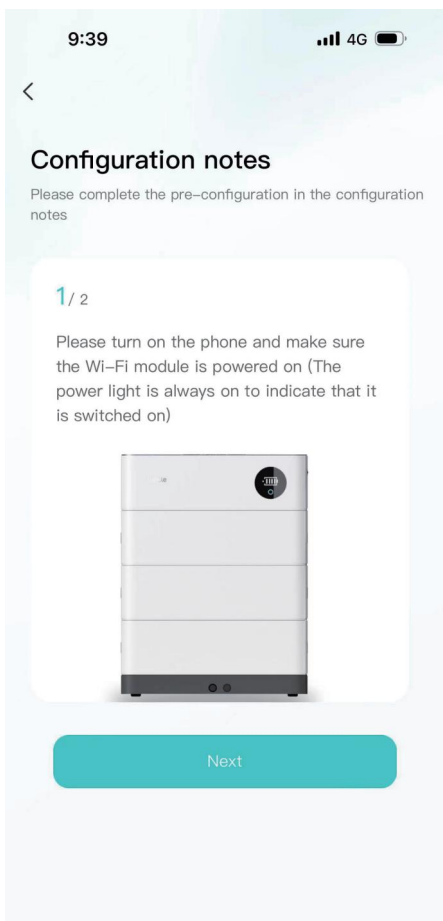

2. Connected devices: The current App supports **Bluetooth search, device scanning, and manual input of SN code** .

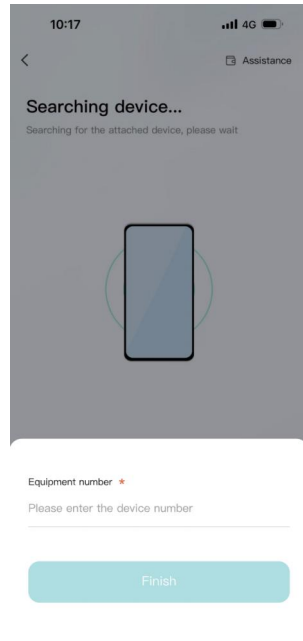
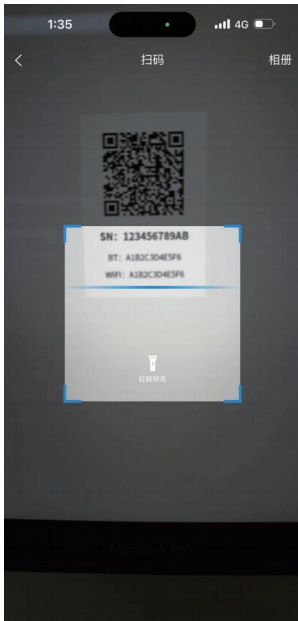
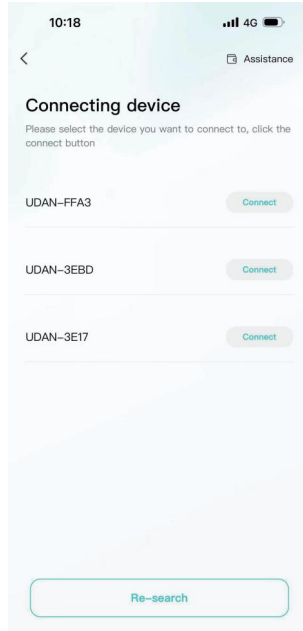
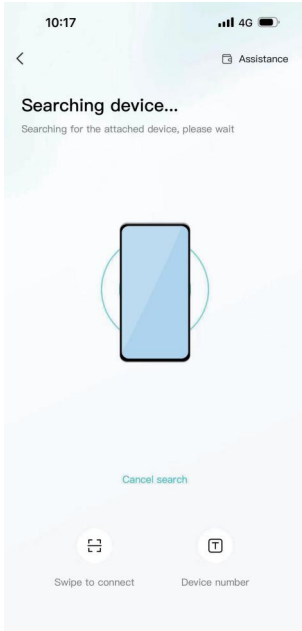

3. Connect to WiFi: After the device is connected, enter the WiFi connection process.
- Select the WiFi you want to use and click the "Connect" button. Enter the WiFi password and click the "Finish" button to distribute the network.

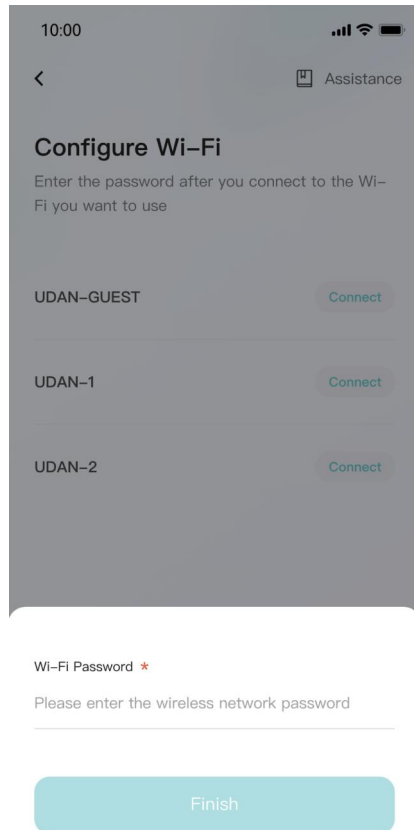
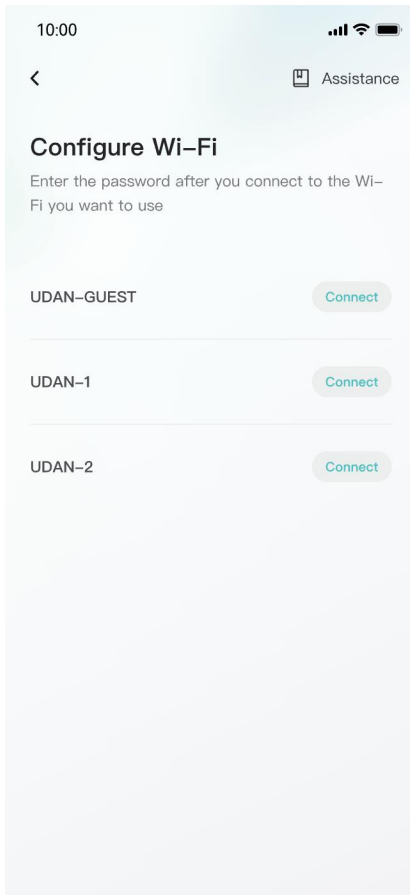

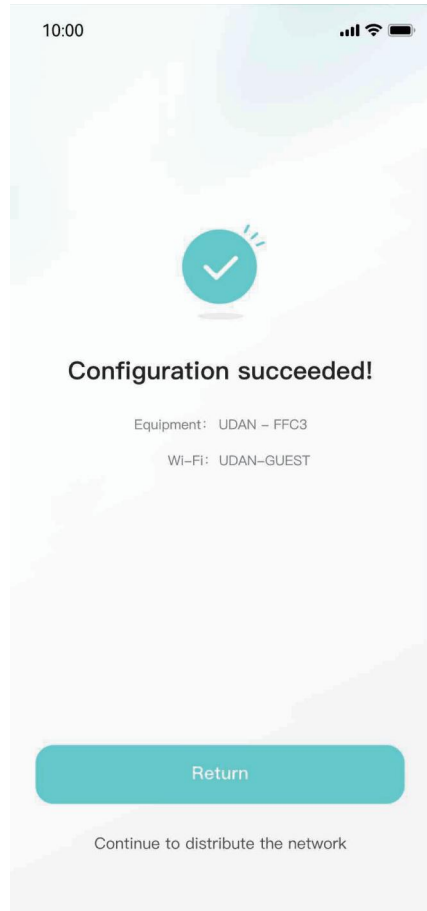
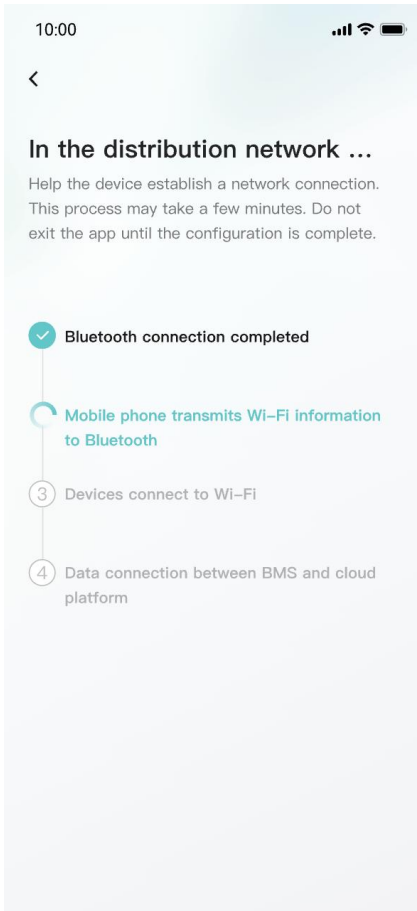

4.4. APP page

4.4.1 Equipment

The device homepage is used to display the currently managed device information.

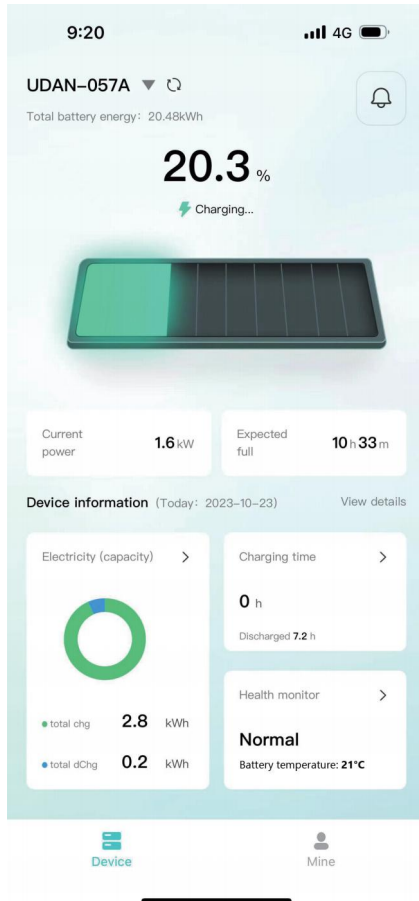

The device homepage is used to display the currently managed device information.

- The top area displays the device name, battery energy, and message entry.

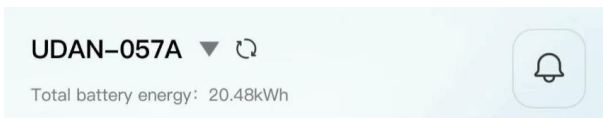

- Middle area: Displays the current battery charging and discharging status, battery percentage, current power, and estimated full time.

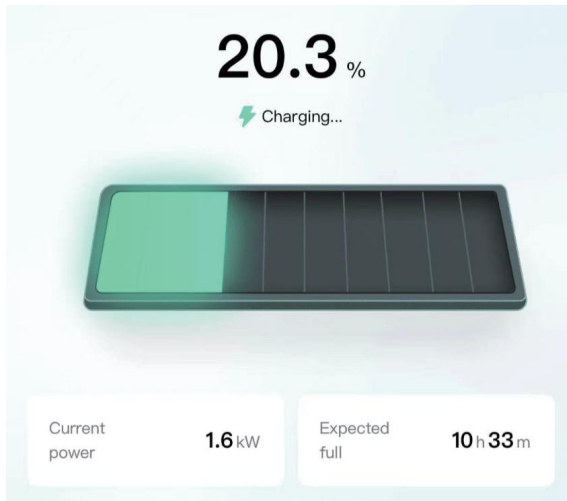

- The bottom area: Displays the device battery, charging time, and health check overview data of the day in the form of a card. You can click the corresponding card to view the details.

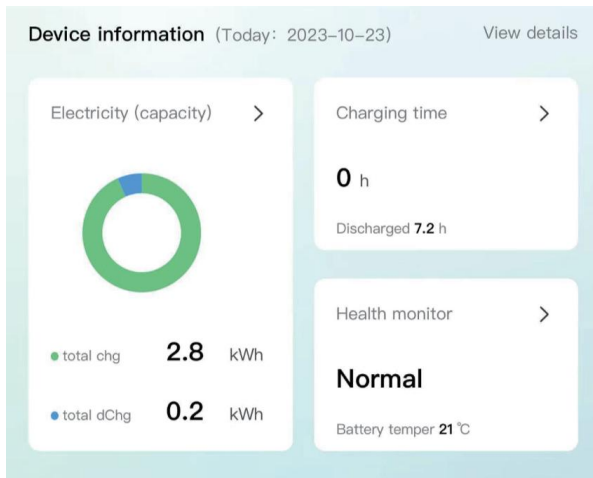

4.4.2 Data details

Display the data details of the current device, and view the battery, charging and discharging power, and charging and discharging time data separately, and support time filtering.

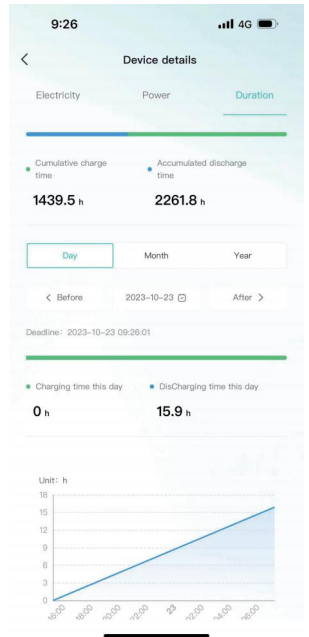
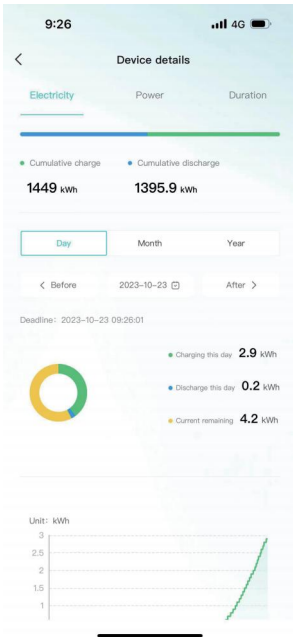

4.5 Mine

The "My" page allows users to view their devices add devices, configure WiFi, software updates, after-sales services, problem feedback, app settings .

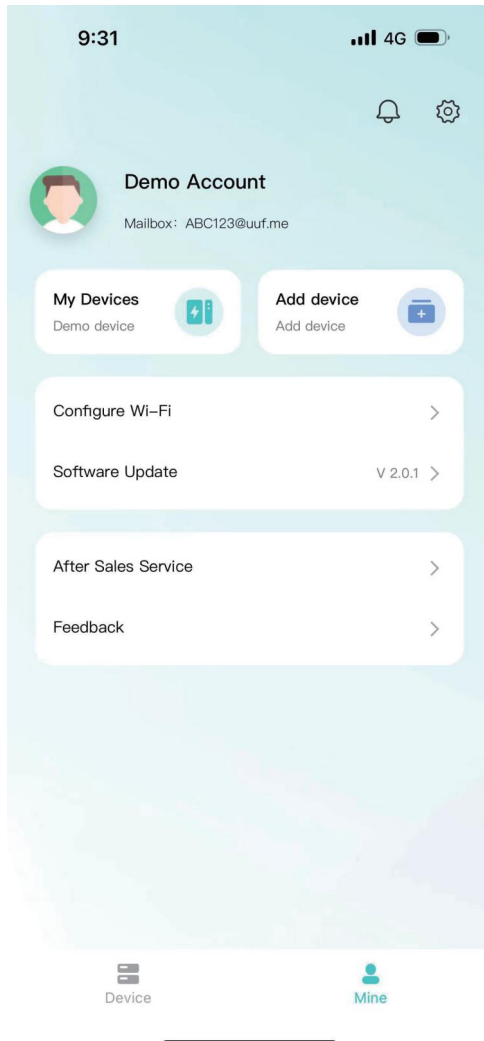

- Click "My Devices" to enter Facility Management. You can view all devices managed under the current account, switch devices displayed on the homepage, unbind devices, and other operations.

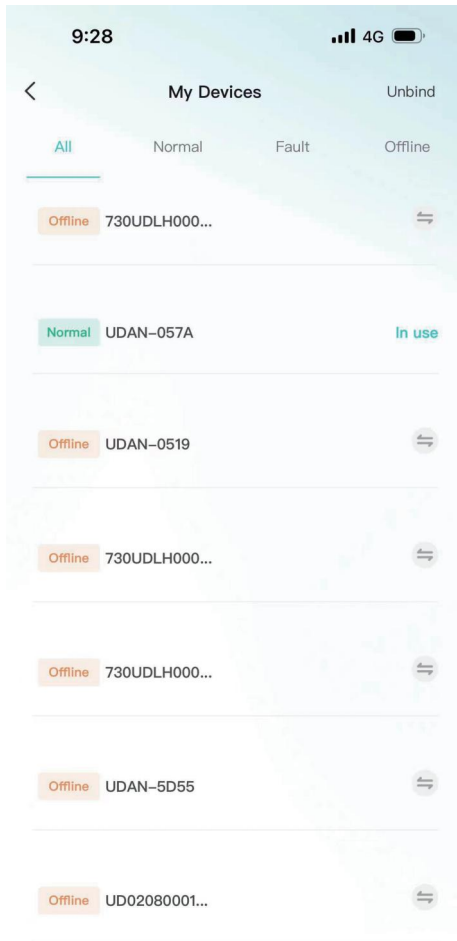

- Click "Add Device" to enter the code scanning page.
- Click "Equipment Distribution Network" to enter the equipment distribution network process.

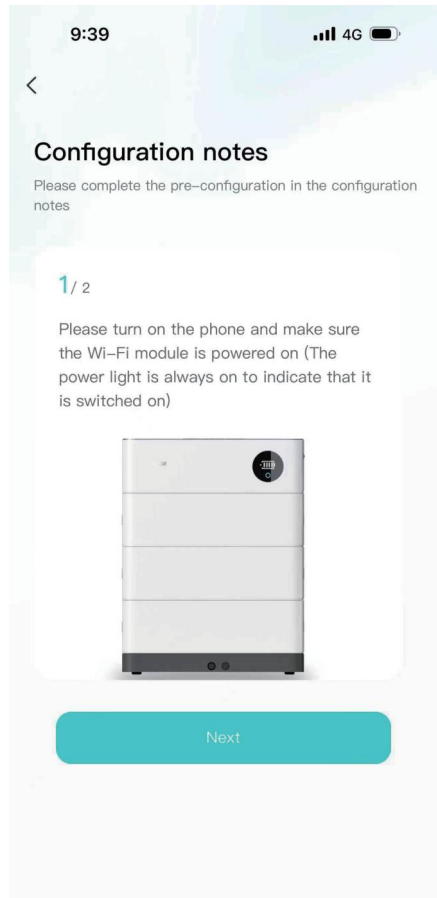

- After clicking "software update", it will enter the version detection. If there is a new version, it will be updated.
- Click "after-sales services" and enter the after-sales services page to display the after-sales service policy of the current supplier.

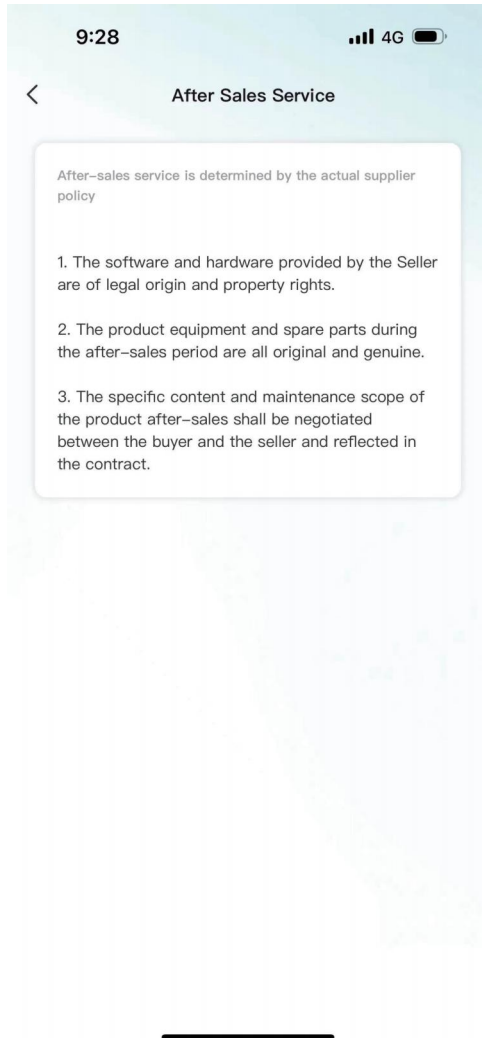

- Click "Feedback" to enter the feedback page. You can enter the current problem that needs feedback and submit it.

9:28 4G

<

Feedback

Please fill in the details of the problem you are experiencing

Title of the problem *

Please enter the title of the problem

Detailed description *

Please provide a detailed description of the problem encountered

Upload an image

+

Upload up to three images, each up to 10M in size

Submit

4.6 Message

Click on the device or my page, the message icon above, you can enter the inbox page to view the current notification or chat history.

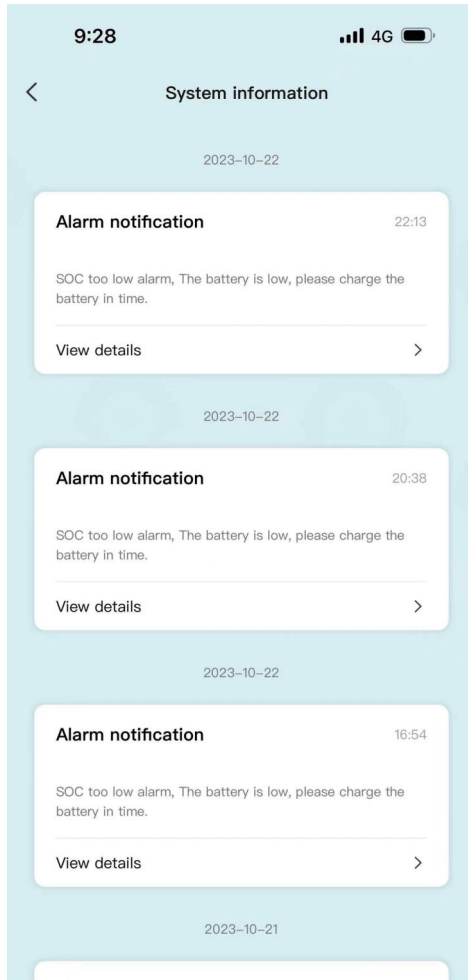

4.7 App settings

- Click My Pages - Settings icon in the upper-right corner to enter the App Settings page.
- Settings page support: language switching, Privacy Policy, cache cleaning, personal information, account and security.

9:28

4G



Settings

- Language Switch English >
- Privacy Policy >
- Cache Cleanup 4.0MB >

- Personal Information >
- Account and Security >

Logout

V. Installation

5.1 Preparation

5.1.1 Safety Compliance

The system installation must be finished by qualified person(s), During the whole installation process, please strictly follow the local safety regulations and related operating procedures.

5.1.2 Environment

The operating environment shall meet the following requirements:

Category	Description
Working temperature	-20°C-55°C(maximum operating range) 15°C-30°C (optimal temperature)
Relative humidity	5%~90%, No condensation
Altitude	<3000m
Safety requirement	<ul style="list-style-type: none">• Do not expose the battery to direct sunlight, rain and snow.• Do not place the battery within children/pet touchable area.• Do not place the battery near heat source and flammable material• Do not place the battery in a closed place where the ventilation is not available.• Do not drop, deform, impact, cut or spearing with a sharp object.• Do not put heavy things on battery.• Do not disassemble the battery without Manufacturer's permission.• No conductive dust, water, or other liquids shall come into contact with the battery.• Follow the emergency measure if there is water invasion or electrolyte and gas leakage.• Contact your supplier within 24 hours if any product failure happens.

5.1.3 Tools



Tools	
Screwdriver (slot, cross)	Multi-meter
Wrench	Clamp meters
Diagonal pliers	Insulating tape
Needle nose pliers	Thermometer (observe the installation environment)
Clamping pliers	Anti-static bracelet
Wire stripper	cable ties







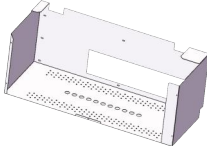
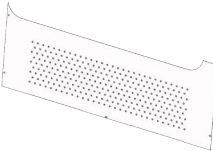
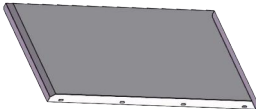

5.2 Inspection

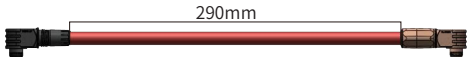
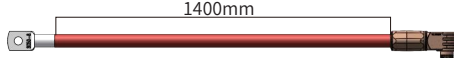
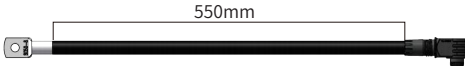
5.2.1 Unpack precautions

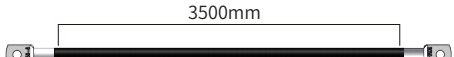
- * Please load and unload it in accordance with the specified requirements to prevent sun and rain when you receive the equipment.
- * Please check and confirm the goods (such as quantity, appearance, etc.) according to the "scope of delivery " before unpacking.
- * Do light take and put during unpacking process to protect the surface coating of the object;
- * Please record and contact to the manufacturer if the inner packing is damaged after unpacking.

5.2.2 Scope of delivery

General materials		
 <p>High Voltage Cabinet * 1</p>	 <p>Battery Cabint * 13</p>	
 <p>Rodent-proof net cover</p>	 <p>Rodent-proof mesh cover plate</p>	 <p>Waterproof top cover</p>

Type	Detail	Qty.
Cables	PACK Series - Power Line A 	
	PACK - High Voltage Box - Positive Power Line 	
	PACK - High Voltage Box - Negative Power Line 	
	Inter column Pack series line 	
	High voltage box PCS positive power line 	
	High voltage box PCS negative power line 	
	Inter column pack ground wire 	
	Battery ground wire 	
	Serial RJ45 crystal communication cable 	
	Intercolumn RJ45 Crystal Communication Cable 	
	High voltage box PCS communication line 	

Delivery Based On Actual Needs

**NOTICE**

Keep the unused cable pins unconnected to avoid affecting the closed loop communication.

**NOTICE**

A ground connection for the communication cable may be required by some inverters

5.3 Start Installation

Qualified person

5.3.1 Reminder

Please check again the following conditions or equipment whether meet the requirements before installation:

- * Check if there is enough space for installation and if the load-bearing capacity of the bracket or cabinet meets the weight requirement
- * Check whether the power cable pair(s) used meets the maximum current requirement for operation;
- * Check whether the overall layout of power supply equipment and batteries at the construction site is reasonable;
- * Check whether the installer is wearing an anti-static wristband.
- * Check whether there're two people on the construction site for installation work
- * Check if there's potential risks at location of installation site, e.g flooding, sun exposure, corrosion, and salt spray

6.3.2 Procedures

**CAUTION**

Injuries may result if the product is lifted incorrectly or dropped while being transported or mounted. Wear suitable personal protective equipment for all work on the product.

**CAUTION**

Ensure that no lines are laid in the wall which could be damaged when drilling holes.

5.3.2.1 Unbox

1. Take the battery pack out of the carton.
2. Stack the high-voltage boxes and modules according to requirements
3. Place the product on a suitable surface and fasten the cables and locking screws.
4. Finish the cable connection.



NOTICE

For all other installations, please avoid direct contact between the battery and the ground, and avoid environments with high salinity and humidity to prevent the product from rusting or corroding.

VI. Cable Connection and Commissioning

Qualified person

6.1 Get Battery Ready

6.1.1 Ensure all the battery is in OFF mode, and confirm the installation is tight and stable.

6.1.2 Check the number and specification of cable kit accessories are correct according to the Scope of delivery item, if you are making cable yourself, please follow manufacturer's requirements.

6.1.3 Switch on all battery individually, check whether there is any alarm/protection information, if yes, refer to the Troubleshooting section. Then switch off all batter

6.2 Communication Cable Connection

6.2.1 Take out battery to battery communication cable.

6.2.2 Insert the communication cable connector into the communication socket of the battery module in turn.

6.2.3 Take out battery to battery power cable.

6.2.4 The module is equipped with a quick-connect terminal, and the power cord can be directly inserted into the terminal to connect the module in series.

6.2.5 Connect the power and communication cables of the module with the high-voltage box

- Communication line
- Negative power line
- Positive power line

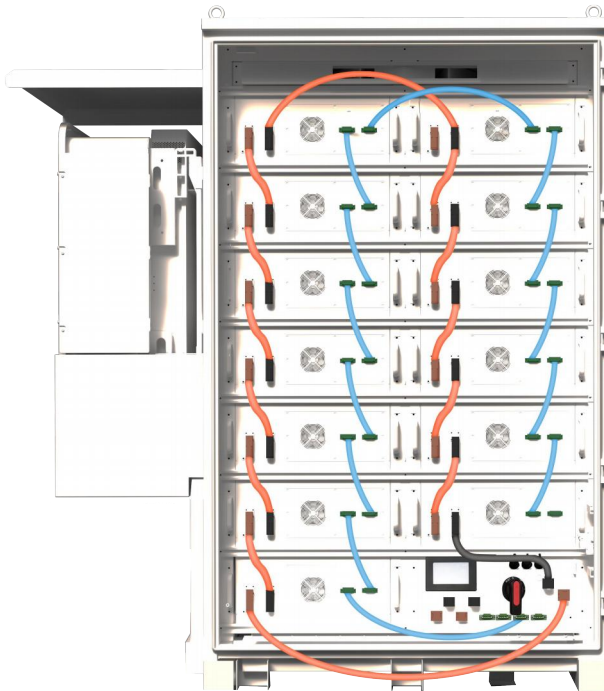

6.4 Connecting with Inverter



CAUTION

Confirm that the inverter's AC input and PV input are disconnected before wiring connection, and the DC/signal switch of inverter/charger is in off status.

6.4.1 Connecting high voltage cabinet PCS port with PCS CAN or RS485 communication port via PCS communication cable.



NOTE

Choose the suitable disconnection breaker considering the inverter power/current, rated voltage, tripping characteristic etc.

Wiring diagram allowed:

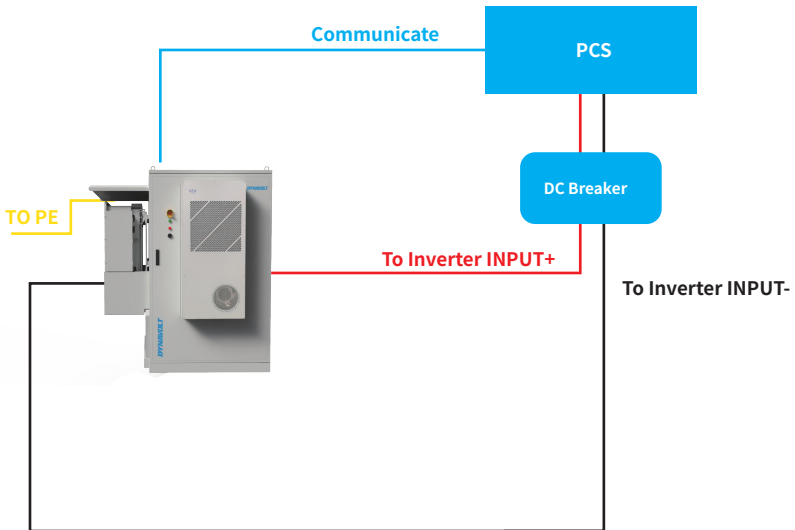



NOTICE

The maximum length of the communication cable between the inverter/charger and the battery shall be less than 15m between inverter/charge and battery.

The maximum power cable length is suggested to be less than 10m between inverter/charge and battery.

For other type of installation, please also follow the rules above to wiring your system.



CAUTION

The maximum current-carrying capacity of each power cable and terminal is 200A, and it is recommended that the continuous current be 150A please use corresponding number of power cable pairs according to the field configuration and local connection requirements, standards, and directives.

6.5 Commissioning

6.5.1 Turn on the switch of the high-voltage box and wait for 1 minute to confirm that the communication between the high-voltage box and the battery modules is successful

6.5.2 Turn on the breaker between the inverter and battery if there is any, then turn on the inverter/charger isolation switch

6.5.3 Finish the setting on inverter/charger or any other control devices. If everything is correct, you are ready to use the system.



CAUTION

If your system is an back-up or off-grid system, make sure your configuration can cover the worst situation to avoid battery to be over-discharged.

6.6 Switch off Battery

6.6.1 Turn off the inverter.

6.6.2 Turn off the disconnection breaker if there is any.

6.6.3 Turn off all batteries power switch

VII .Troubleshooting

Items	Solution	Measure
Unable to start	Charge the battery using a charger or inverter to provide Operating voltage and observe it can be started.	<p>If the abnormal status still alive after above steps, please contact your supplier.</p> <p>If there is any other situation(s) excluding in this table, turn off the fault battery, contact your supplier.</p>
Unable to charge	<ol style="list-style-type: none"> 1. Check whether the cable connection between the battery and the inverter/charger is correct. 2. Check whether the inverter/charger setting is correct. 3. Check whether the battery is in charge protection mode, if yes, try to discharge the battery. 	
Unable to discharge	<ol style="list-style-type: none"> 1. Check whether the cable connection between the battery and the inverter/charger is correct 2. Check whether the battery occurs short circuit, reverse connection, pre-charge failure during connection inverter etc. 3. Check whether the battery is in discharge protection mode, if yes, try to charge the battery. 	
High/Low temperature	<ol style="list-style-type: none"> 1. Shut down the battery system temporarily, check whether the installation location temperature meet the requirement. 2. Avoid continuous full charging and discharging 	
High current	Check the configuration and parameters setting on the inverter/charger is correct.	
ALM ON	Turn off all the batteries, and remove the fault battery from the system.	
Communication fail	<ol style="list-style-type: none"> 1. Check the communication cable type is correct and is contacted well. 2. Check the inverter protocol related setting is correct. 3. Check both battery and inverter are working properly. 	



NOTICE

Please restart after software is upgraded.

VIII. Transport and Storage

- * Do not violently shake, impact or squeeze, and prevent sun and rain during the transportation.
- * Do handle with care and strictly prevent falling, rolling, and heavy pressure during loading and unloading.
- * The battery should be placed in a dry, clean, dark, and well-ventilated indoor environment for long- term storage, and the recommended storage temperature range is 25~40°C .
- * No harmful gases, flammable and explosive products and corrosive chemical substances in the storage location.
- * The batteries should be stored and transported at approximately 50% SOC, and do not store at over 80% SOC for a long time.
- * If do not use for a time, The battery needs to be charged every 6 months if it is not used for a long time.
- * Do not drop or stack the batteries.

IX. Disposal of Battery

Disposal of battery must comply with the applicable local disposal regulations for electronic waste and used batteries, Please review your local battery recycling or management regulations